Iowa Prison Industries ImageMaker Modular System

New • Refurbished • As Is



Price List & Ordering Guide

Please consult your sales representative for project-based pricing.



Iowa Prison Industries

Division of The Department of Corrections

1445 E Grand Avenue

Des Moines, IA 50316

800-670-4537 • www.iaprisonind.com

Prices effective 01/21/11; prices & specifications are subject to change without notice.

TABLE OF CONTENTS

Fabric Covered Hard Surface Panels	1
Panel Components.....	2
<i>Two-Way 90 Degree Connectors</i>	2
<i>Three-Way Connectors</i>	2
<i>Four-Way Connectors</i>	2
<i>Two-Way 180 Degree Connectors</i>	2
<i>Finished Ends</i>	3
<i>Draw Rods</i>	3
<i>Variable Height Filler Strip</i>	3
<i>Wall Hanger Strips</i>	4
<i>Wall Starts</i>	4
Energy Components: 8 Wire 4 Circuit for "A" Series	5
<i>Power Box Cables</i>	5
<i>Pass-Thru Jumpers</i>	5
<i>Connector Jumper</i>	5
<i>Power Entry</i>	5
<i>Electric Receptacles</i>	5
Wire Management: "A" Series for 8 Wire	6
<i>Non-Powered Wire Management</i>	6
<i>Powered Wire Management</i>	6
<i>Trim Pieces</i>	6
Work Surfaces: "A" Series.....	7
<i>Rectangular Work Surfaces</i>	7
<i>Corner Work Surfaces</i>	7
<i>End Supports</i>	7
<i>Peninsulas</i>	8
<i>Counter Caps</i>	8
Overhead Storage: "A" Series	9
<i>Flipper Units, Complete</i>	9
<i>EDP Flipper Units, Complete</i>	9
<i>Low Shelf Units</i>	9
<i>High Shelf Units</i>	9
<i>EDP High Shelf Units</i>	9
<i>Flipper Door Kit</i>	10
<i>EDP Flipper Door Kit</i>	10
Tack Boards "A" Series	11
Hanging Lateral Files	11
Marker Boards	11
Pedestal Files	12
<i>Two Drawer Hanging Files</i>	12
<i>Work Surface Supporting Files</i>	12
<i>Mobile Files</i>	12
<i>Center File</i>	12
<i>Drawer Dividers</i>	12
Freestanding Lateral Files	13
Accessories	14
<i>Pencil Drawers</i>	14
<i>Lateral File Conversion Bar</i>	14
<i>Task Lights</i>	14
<i>Under Counter Task Light</i>	14
<i>Keyboard Trays</i>	14

FABRIC COVERED HARD SURFACE PANEL

PRICE INCLUDES PANEL, HANGER FRAMES, PANEL SHELLS, PVC TOP CAP, GLIDES & GRADE 1 FABRIC.

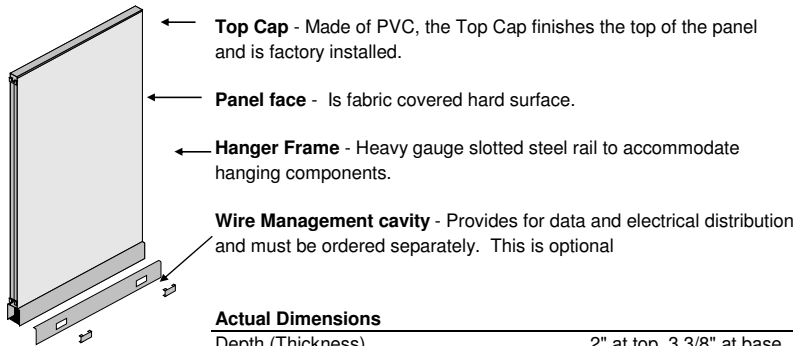

To convert to metal top caps add:	
\$3.30	12" panel
3.50	24" panel
4.00	30" panel
4.50	36" panel
5.00	42" panel
6.00	48" panel
7.25	60" panel

Actual Dimensions

Depth (Thickness)	2" at top, 3 3/8" at base
Width	12", 24", 30", 36", 42", 48" & 60"
Height with Action Style Raceway	38", 46", 52", 66" & 84"
Height without Raceway	34", 42", 48", 62" & 80"

Specify:

- * Product number
- * Trim color
- * Fabric Style & Color

Note:

- * Order Finished End to finish exposed panel end.
- * Order Panel Connectors
- * Special fabrics may affect yardage requirements & costs
- * Order Wire Management, if needed

DIMENSION: H x W	ITEM NUMBER	REFURBISHED
34 x 12	FIMP3412	\$ 69.00
34 x 24	FIMP3424	\$ 74.00
34 x 30	FIMP3430	\$ 91.00
34 x 36	FIMP3436	\$ 96.00
34 x 42	FIMP3442	\$ 99.00
34 x 48	FIMP3448	\$ 102.00
34 x 60	FIMP3460	\$ 114.00

DIMENSION: H x W	ITEM NUMBER	REFURBISHED
62 x 12	FIMP6212	\$ 93.00
62 x 24	FIMP6224	\$ 99.00
62 x 30	FIMP6230	\$ 130.00
62 x 36	FIMP6236	\$ 134.00
62 x 42	FIMP6242	\$ 138.00
62 x 48	FIMP6248	\$ 141.00
62 x 60	FIMP6260	\$ 143.00

42 x 12	FIMP4212	\$ 75.00
42 x 24	FIMP4224	\$ 80.00
42 x 30	FIMP4230	\$ 99.00
42 x 36	FIMP4236	\$ 104.00
42 x 42	FIMP4242	\$ 108.00
42 x 48	FIMP4248	\$ 113.00
42 x 60	FIMP4260	\$ 118.00

80 x 12	FIMP8012	\$ 112.00
80 x 24	FIMP8024	\$ 120.00
80 x 30	FIMP8030	\$ 156.00
80 x 36	FIMP8036	\$ 159.00
80 x 42	FIMP8042	\$ 161.00
80 x 48	FIMP8048	\$ 165.00
80 x 60	FIMP8060	\$ 174.00

48 x 12	FIMP4812	\$ 80.00
48 x 24	FIMP4824	\$ 86.00
48 x 30	FIMP4830	\$ 110.00
48 x 36	FIMP4836	\$ 113.00
48 x 42	FIMP4842	\$ 119.00
48 x 48	FIMP4848	\$ 122.00
48 x 60	FIMP4860	\$ 125.00

HALF GLAZED PANELS		
62"h x 24"w	FIMPHG6224XX	\$ 274.00
62"h x 30"w	FIMPHG6230XX	\$ 298.00
62"h x 36"w	FIMPHG6236XX	\$ 323.00
62"h x 48"w	FIMPHG6248XX	\$ 365.00
80"h x 24"w	FIMPHG8024XX	\$ 331.00
80"h x 30"w	FIMPHG8030XX	\$ 372.00
80"h x 36"w	FIMPHG8036XX	\$ 397.00
80"h x 48"w	FIMPHG8048XX	\$ 437.00

STANDARD TRIM COLORS:	LN	Light Neutral
	MT	Medium Tone
	DT	Dark Tone
	HF	Innertone Light

Note: These are the only sizes available.

Refurbished: Looks like new, with new fabric

PANEL COMPONENTS

Specify:

- * Product number
- * Trim color
- * Wire Management trim, if needed

Actual Dimensions

Width	3 1/2"
Height with Action Style Raceway	38", 46", 52", 66" & 84"
Height without Raceway	34", 42", 48", 62" & 80"

TWO WAY 90 CONNECTOR

CONNECTS TWO PANELS AT 90 DEGREES. ORDER **RIM142.02** TWO WAY 90 RACEWAY TRIM SEPARATELY, IF NEEDED.

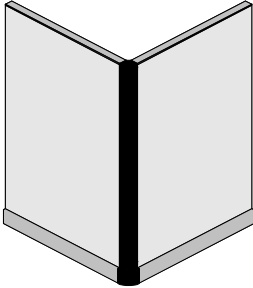

DIMENSION: H	ITEM NUMBER	REFURBISHED
34	RIM259.34	\$ 23.00
42	RIM259.42	\$ 29.50
48	RIM259.48	\$ 31.50
62	RIM259.62	\$ 35.50
80	RIM259.80	\$ 47.50

THREE WAY CONNECTOR

CONNECTS THREE PANELS AT A "T". ORDER **RIM142.03** THREE WAY RACEWAY TRIM SEPARATELY, IF NEEDED.

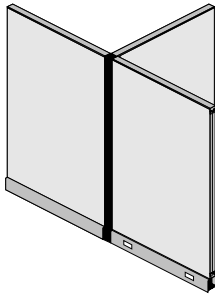

DIMENSION: H	ITEM NUMBER	REFURBISHED
34	RIM261.34	\$ 30.00
42	RIM261.42	\$ 34.00
48	RIM261.48	\$ 37.00
62	RIM261.62	\$ 42.00
80	RIM261.80	\$ 53.00

FOUR WAY CONNECTOR

CONNECTS FOUR PANELS AT AN INTERSECTION. ORDER **RIM142.04** FOUR WAY RACEWAY TRIM SEPARATELY, IF NEEDED.

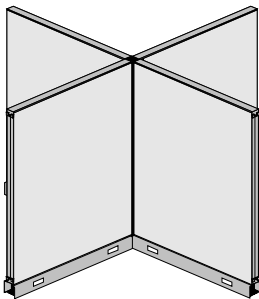

DIMENSION: H	ITEM NUMBER	REFURBISHED
34	RIM262.34	\$ 35.00
42	RIM262.42	\$ 39.50
48	RIM262.48	\$ 45.00
62	RIM262.62	\$ 52.00
80	RIM262.80	\$ 64.00

TWO WAY 180 DEGREE CONNECTOR

CONNECTS PANELS OF EQUAL OR UNEQUAL HEIGHTS FOR DIMENSIONAL GAIN. ORDER **RIM142.07** TWO WAY 180 RACEWAY TRIM SEPARATELY, IF NEEDED.

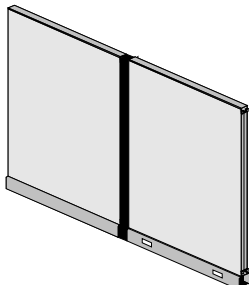

DIMENSION: H	ITEM NUMBER	REFURBISHED
34	RIM260.34	\$ 37.50
42	RIM260.42	\$ 37.50
48	RIM260.48	\$ 41.00
62	RIM260.62	\$ 46.00
80	RIM260.80	\$ 53.50

As Is: Cleaned, subject to availability

PANEL COMPONENTS

Specify:

- * Product number
- * Trim color
- * Wire Management trim, if needed

Actual Dimensions

Width	3 1/2"
Height with Action Style Raceway	38", 46", 52", 66" & 84"
Height without Raceway	34", 42", 48", 62" & 80"

FINISHED END

FINISHES EXPOSED PANEL END. ORDER **RIM142.01** RACEWAY TRIM END SEPARATELY, IF NEEDED.

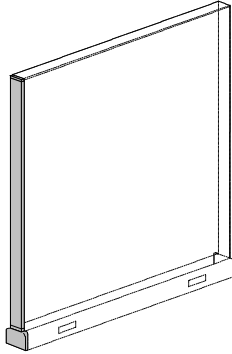

DIMENSION: H	ITEM NUMBER	REFURBISHED
34	RIM171.34	\$ 12.75
42	RIM171.42	\$ 14.00
48	RIM171.48	\$ 14.50
62	RIM171.62	\$ 16.50
80	RIM171.80	\$ 17.50

PANEL CONNECTOR DRAW ROD - DT ONLY

CONNECTS TWO PANELS IN A STRAIGHT LINE.

Specify:

- * Product number.

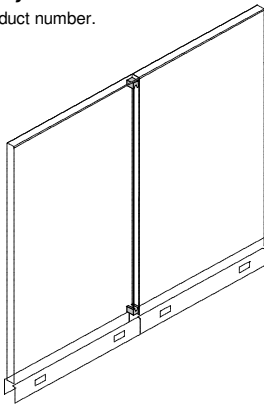

DIMENSION: H	ITEM NUMBER	REFURBISHED
34	RIM175.34	\$ 5.75
42	RIM175.42	\$ 6.25
48	RIM175.48	\$ 6.50
62	RIM175.62	\$ 7.25
80	RIM175.80	\$ 9.00

VARIABLE HEIGHT FILLER STRIP - RIGID

FINISHES EXPOSED END OF CONNECTOR OR PANEL WHEN JOINING PANELS OF DIFFERENT HEIGHTS. CUT TO LENGTH AS REQUIRED.

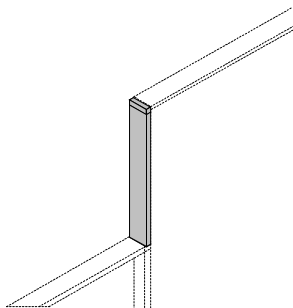

DIMENSION:	ITEM NUMBER	NEW
VARIABLE HEIGHT STRIPS - 4' LENGTH	RIM132.04	\$ 6.25

As Is: Cleaned, subject to availability

PANEL COMPONENTS

WALL HANGER STRIP

HIGH QUALITY BRUSHED ALUMINUM EXTRUSION WITH HEAVY DUTY 16 GAUGE STEEL SLOTTED INSERT IS USED TO HANG COMPONENTS OR WORK SURFACES DIRECTLY FROM A WALL. RECOMMEND ONE (1) WALL FASTENER **SHWR396** PER FOOT.

Specify:

* Product number

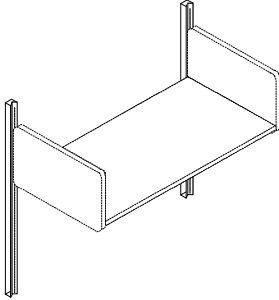

<i>DIMENSION:</i> <i>H</i>	<i>ITEM</i> <i>NUMBER</i>	<i>NEW</i>	
84" WALL STRIP	RIM120.84	\$	19.25
CAN BE CUT DOWN TO SMALLER SIZES			
TOGGLE BOLT & ANCHOR	SHWR396	\$	0.95

T-CONNECTOR (WALL START)

CONNECTS PANEL TO AN EXISTING STRUCTURAL WALL TO BEGIN A PANEL RUN. A DRAW ROD ASSEMBLY IS REQUIRED TO ATTACH PANEL TO THE T-CONNECTOR

Specify:

* Product number

* Trim color

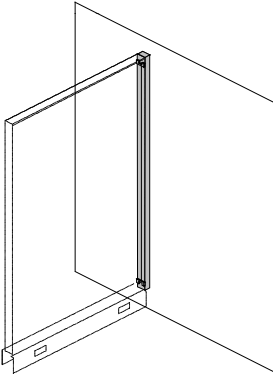

<i>DIMENSION:</i> <i>H</i>	<i>ITEM</i> <i>NUMBER</i>	<i>NEW</i>	
34	RIM184.34	\$	15.00
42	RIM184.42	\$	16.00
48	RIM184.48	\$	16.00
62	RIM184.62	\$	17.50
80	RIM184.80	\$	20.00

ENERGY COMPONENTS 8 WIRE-4 CIRCUIT FOR "A" SERIES

8 WIRE-4 CIRCUIT POWER BOX CABLES

USE WITH CUSTOM "A" SERIES POWERED WIRE MANAGEMENT. INCLUDES UP TO TWO POWER BLOCKS WHICH ACCOMMODATE UP TO FOUR RECEPTACLES. ORDER RECEPTACLES SEPARATELY.

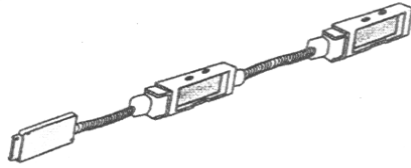

<i>DIMENSION:</i>	<i>ITEM NUMBER</i>	<i>NEW</i>
-------------------	--------------------	------------

24" Single	RPE24PB	\$ 39.50
30"	RPE30PB	\$ 48.50
36"	RPE36PB	\$ 52.50
42"	RPE42PB	\$ 57.50
48"	RPE48PB	\$ 57.50
60"	RPE60PB	\$ 60.50

8 WIRE-4 CIRCUIT PANEL PASS THRU JUMPERS

USE THIS FLEXIBLE CONDUIT CABLE TO PASS POWER THROUGH NONPOWERED WIRE MANAGEMENT AND CONNECT WITH ANOTHER ELECTRICAL POWER BOX CABLE.

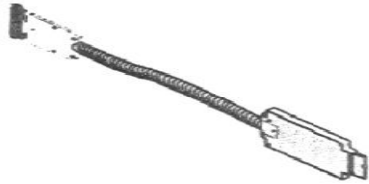

12"	RPE12PT	\$ 24.50
24"	RPE24PT	\$ 27.50
30"	RPE30PT	\$ 29.50
36"	RPE36PT	\$ 32.00
42"	RPE42PT	\$ 33.00
48"	RPE48PT	\$ 36.50
60"	RPE60PT	\$ 40.50
96"	RPE96PT	\$ 53.00

8 WIRE-4 CIRCUIT 3" PANEL CONNECTOR JUMPER

USED WHEN RUNNING POWER FROM PANEL TO PANEL THROUGH A CONNECTOR OR A SPACER POST

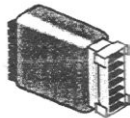

3" EXTENDER	RPE3EXT	\$ 15.50
-------------	---------	----------

8 WIRE-4 CIRCUIT POWER ENTRY

CONNECTS A BUILDING'S ELECTRICAL SUPPLY FROM THE CEILING, WALL, OR FLOOR TO THE BASE OF A PANEL.

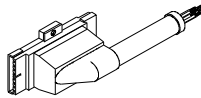

72" POWER FEED-END	RPEP40E	\$ 51.50
72" POWER FEED-SIDE	RPEP40S	\$ 54.00
144" CEILING INFEEED	RPEC20E	\$ 55.00

8 WIRE-4 CIRCUIT ELECTRICAL RECEPTACLES (BLACK ONLY)

PLUGS INTO THE ELECTRICAL POWER BOXES. SELECT CIRCUITS 1, 2, 3 OR 4

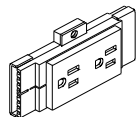

CIRCUIT 1	RPE8010B	\$ 9.75
CIRCUIT 2	RPE8020B	\$ 9.75
CIRCUIT 3	RPE8030B	\$ 9.75
CIRCUIT 4	RPE8040B	\$ 9.75

WIRE MANAGEMENT "A" SERIES FOR 8 WIRE-4 CIRCUIT ELECTRICAL

"A" SERIES POWERED AND NON-POWERED WIRE MANAGEMENT KITS FOR 8 WIRE-4 CIRCUIT ELECTRICAL

PROVIDES A 4" WIRE MANAGEMENT RACEWAY AT THE BASE OF A PANEL

POWERED KIT INCLUDES TWO POWERED SIDE COVERS AND ONE METAL BASE TRAY WITH CLIPS FOR POWER RECEPTACLES.

NON-POWERED KIT INCLUDES TWO NON-POWERED SIDE COVERS AND ONE METAL BASE TRAY WITHOUT CLIPS.

ORDER RIM142.05 PANEL FILLERS SEPARATELY

ORDER RHMP550.01 OUTLET COVERS SEPARATELY.

DIMENSION:		ITEM	
WIDTH	NUMBER		NEW
POWERED KIT			
24" Single	RHMU320.24	\$	13.75
30"	RHMU320.30	\$	16.50
36"	RHMU320.36	\$	19.25
42"	RHMU320.42	\$	20.75
48"	RHMU320.48	\$	23.25
60"	RHMU320.60	\$	27.50
NON-POWERED KIT			
12"	RIM148.12	\$	9.00
24"	RIM148.24	\$	12.00
30"	RIM148.30	\$	14.50
36"	RIM148.36	\$	16.00
42"	RIM148.42	\$	18.00
48"	RIM148.48	\$	20.00
60"	RIM148.60	\$	23.50

"A" SERIES RACEWAY COMPONENT OPTIONS FOR 8 WIRE-4 CIRCUIT ELECTRICAL

DIMENSION:		ITEM	
WIDTH	NUMBER		NEW
POWERED COVERS (PAIR)			
24" Single	RHMP320.24	\$	7.25
30"	RHMP320.30	\$	8.50
36"	RHMP320.36	\$	10.50
42"	RHMP320.42	\$	11.75
48"	RHMP320.48	\$	13.50
60"	RHMP320.60	\$	16.75
NON-POWERED COVERS (PAIR)			
12"	RIM186.12	\$	4.00
24"	RIM186.24	\$	6.00
30"	RIM186.30	\$	7.75
36"	RIM186.36	\$	9.00
42"	RIM186.42	\$	10.25
48"	RIM186.48	\$	11.75
60"	RIM186.60	\$	14.50

DIMENSION:		ITEM	
WIDTH	NUMBER		NEW
BASE PLATE WITH RECEPTACLE CLIPS			
24" Single	RHMA371.24	\$	6.50
30"	RHMA371.30	\$	8.00
36"	RHMA371.36	\$	8.75
42"	RHMA371.42	\$	9.00
48"	RHMA371.48	\$	9.75
60"	RHMA371.60	\$	10.75
BASE PLATE WITHOUT CLIPS			
12"	RHMP370.12	\$	5.00
24"	RHMP370.24	\$	6.00
30"	RHMP370.30	\$	6.75
36"	RHMP370.36	\$	7.00
42"	RHMP370.42	\$	7.75
48"	RHMP370.48	\$	8.25
60"	RHMP370.60	\$	9.00

"A" SERIES WIRE MANAGEMENT TRIM KITS FOR 8 WIRE-4 CIRCUIT ELECTRICAL

PROVIDES 4" WIRE MANAGEMENT COVERS AT BASE OF CONNECTORS, END CAPS AND BETWEEN PANELS.

KITS INCLUDE PINS.

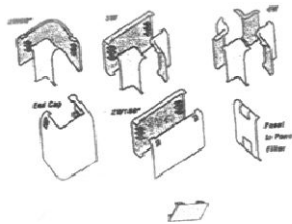

DESCRIPTION	ITEM NUMBER		NEW
END CAP	RIM142.01	\$	4.00
2WAY 90	RIM142.02	\$	5.00
2WAY 180	RIM142.07	\$	6.25
3WAY	RIM142.03	\$	6.00
4WAY	RIM142.04	\$	5.00
PNL FILLER (PR)	RIM142.05	\$	2.00
OUTLET COVER	RHMP550.01	\$	1.50

"A" SERIES WORK SURFACES

Specify:

- * Product number.
- * T Edge color (DT, LN, MT, HF)
- * Laminate

RECTANGULAR WORK SURFACE WITH SUPPORT ARMS



<i>DIMENSION: W x D</i>	<i>ITEM NUMBER</i>	<i>REFURBISHED</i>	
24 x 24	FIMWS2424	\$	50.00
30 x 24	FIMWS3024	\$	55.00
36 x 24	FIMWS3624	\$	60.00
42 x 24	FIMWS4224	\$	60.00
48 x 24	FIMWS4824	\$	65.00
60 x 24	FIMWS6024	\$	87.00
72 x 24	FIMWS7224	\$	103.00
24 x 30	FIMWS2430	\$	82.00
30 x 30	FIMWS3030	\$	88.00
36 x 30	FIMWS3630	\$	94.00
42 x 30	FIMWS4230	\$	100.00
48 x 30	FIMWS4830	\$	106.00
60 x 30	FIMWS6030	\$	120.00
72 x 30	FIMWS7230	\$	145.00

CORNER WORK SURFACE WITH CORNER BRACKET, SUPPORT ARMS AND GROMMET

USE FOR 90 DEGREE CORNERS.



<i>DIMENSION: W x D</i>	<i>ITEM NUMBER</i>	<i>REFURBISHED</i>	
36 x 24	FIMCWS3624	\$	90.00
42 x 24	FIMCWS4224	\$	107.00
48 x 24	FIMCWS4824	\$	115.00
36 x 30	FIMCWS3630	\$	97.00
42 x 30	FIMCWS4230	\$	115.00
48 x 30	FIMCWS4830	\$	125.00

WORK SURFACE SUPPORT PANEL END

PANEL END HAS LAMINATE SURFACE AND ATTACHES TO BOTH A PANEL AND WORK SURFACE AT THE END OF A PANEL RUN TO PROVIDE SUPPORT AND ELIMINATE THE NEED FOR A RETURN PANEL AND CONNECTOR.

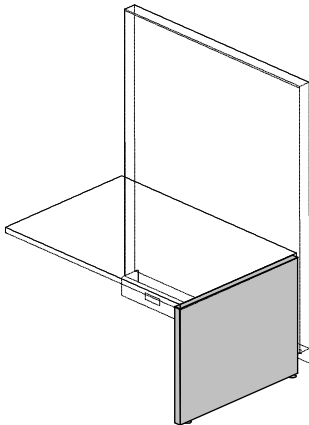

- * Support Panel is non-handed
- * Includes attachment hardware and 2" adjustable glides.
- * Height is 28".

<i>DIMENSION:</i>	<i>ITEM NUMBER</i>	<i>REFURBISHED</i>	
24"	FIMWSE24	\$	72.00
30"	FIMWSE30	\$	80.00

"A" SERIES WORK SURFACES

Specify:

- * Product number.
- * T Edge color (LN, MT, DT, HF)
- * Laminate

PENINSULA WORK SURFACE WITH SUPPORT ARMS

* ORDER A SINGLE OR DOUBLE PENINSULA LEG SEPARATELY.

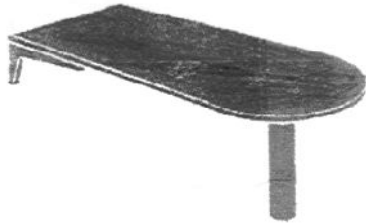

DIMENSION: W x L		ITEM NUMBER	REFURBISHED	
24 x 60	FIMWSP2460	\$	100.00	
24 x 72	FIMWSP2472	\$	110.00	
30 x 60	FIMWSP3060	\$	130.00	
30 x 72	FIMWSP3072	\$	149.00	
36 x 72	FIMWSP3672	\$	158.00	
NEW				
Single Leg	RIMU01601	\$	39.00	
Double Leg	RIMU08001	\$	54.00	

COUNTER CAP WITH SUPPORT BRACKETS

USE ON PANEL CAPS AS TRANSACTION COUNTER FOR SECRETARIAL AND RECEPTION WORKSTATIONS.

NOTE: ORDER SURFACE WIDTH TO MATCH WIDTH OF PANEL OR PANELS.

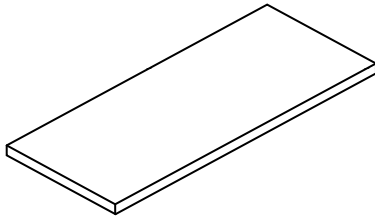

Straight Counter Top

DIMENSION: W x D		ITEM NUMBER	REFURBISHED	
24 x 14	FIMWS2414	\$	40.00	
30 x 14	FIMWS3014	\$	45.00	
36 x 14	FIMWS3614	\$	45.00	
42 x 14	FIMWS4214	\$	50.00	
48 x 14	FIMWS4814	\$	50.00	
60 x 14	FIMWS6014	\$	65.00	
72 x 14	FIMWS7214	\$	75.00	

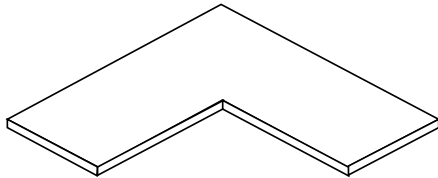

Angled Counter Top

DIMENSION: W x W x D		ITEM NUMBER	REFURBISHED	
24x24x14	FIMCWSC2424	\$	75.00	
36x36x14	FIMCWSC3636	\$	99.00	

FOR PARTS ONLY

WORK SURFACE ARMS & COUNTER CAP BRACKETS ARE SOLD IN PAIRS.

DESCRIPTION:	ITEM NUMBER	REFURBISHED	
24" Wk Surf Arms	RIM27424	\$	15.00
30" Wk Surf Arms	RIM27430	\$	24.00
Counter Cap Brkts	RIM23301	\$	5.00

"A" SERIES OVERHEAD STORAGE

Note:

- * Flipper Door is lockable.
- * Locks can be keyed alike upon request.

Specify:

- * Product number.
- * Product color – (MT, DT, LN with DT ends & HF with MT ends)
- * Fabric style & color on flipper unit.
- * Shelf End color, if different from shelf and top of unit. Standard colors are DT & MT.

FLIPPER UNIT WITH FABRIC COVERED DOOR, COMPLETE.

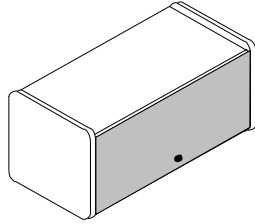

<i>DIMENSION:</i> <i>W x H x D</i>	<i>ITEM</i> <i>NUMBER</i>	<i>REFURBISHED</i>
24 x 15.5 x 12.5	FIMFLIPU.24	\$ 119.00
30 x 15.5 x 12.5	FIMFLIPU.30	\$ 127.00
36 x 15.5 x 12.5	FIMFLIPU.36	\$ 129.00
42 x 15.5 x 12.5	FIMFLIPU.42	\$ 140.00
48 x 15.5 x 12.5	FIMFLIPU.48	\$ 146.00
60 x 15.5 x 12.5	FIMFLIPU.60	\$ 160.00

**EDP FLIPPER UNIT WITH FABRIC COVERED DOOR, COMPLETE
FOR LEGAL SIZE DOCUMENTS**

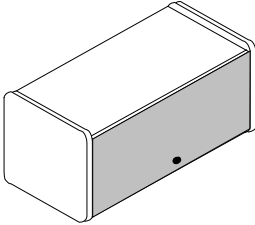

<i>DIMENSION:</i> <i>W x H x D</i>	<i>ITEM</i> <i>NUMBER</i>	<i>REFURBISHED</i>
24 x 15.5 x 15.5	FIMFLIPUD.24	\$ 149.00
30 x 15.5 x 15.5	FIMFLIPUD.30	\$ 164.00
36 x 15.5 x 15.5	FIMFLIPUD.36	\$ 166.50
42 x 15.5 x 15.5	FIMFLIPUD.42	\$ 183.00
48 x 15.5 x 15.5	FIMFLIPUD.48	\$ 189.00
60 x 15.5 x 15.5	FIMFLIPUD.60	\$ 206.00

LOW SHELF UNIT 7.5"H X 12.5"D COMPLETE WITH HANGER CLIPS AND SCREWS.

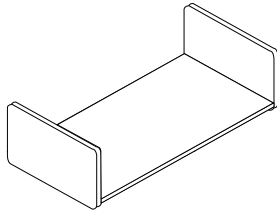

<i>DIMENSION:</i> <i>W</i>	<i>ITEM</i> <i>NUMBER</i>	<i>REFURBISHED</i>
24" SHELF	RHMA281.24	\$ 43.00
30" SHELF	RHMA281.30	\$ 46.00
36" SHELF	RHMA281.36	\$ 48.00
42" SHELF	RHMA281.42	\$ 50.00
48" SHELF	RHMA281.48	\$ 52.00
60" SHELF	RHMA281.60	\$ 58.00

HIGH SHELF UNIT 15.5"H X 12.5"D COMPLETE WITH HANGER CLIPS AND SCREWS.

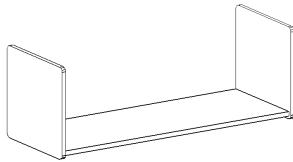

<i>DIMENSION:</i> <i>W</i>	<i>ITEM</i> <i>NUMBER</i>	<i>REFURBISHED</i>
24" SHELF	RIM190.24	\$ 52.00
30" SHELF	RIM190.30	\$ 55.00
36" SHELF	RIM190.36	\$ 56.00
42" SHELF	RIM190.42	\$ 58.00
48" SHELF	RIM190.48	\$ 60.00
60" SHELF	RIM190.60	\$ 65.00

EDP SHELF UNIT (LEGAL SIZE) 15.5"H X 15.5"D COMPLETE WITH HANGER CLIPS AND SCREWS.

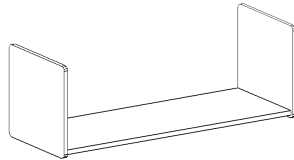

<i>DIMENSION:</i> <i>W</i>	<i>ITEM</i> <i>NUMBER</i>	<i>REFURBISHED</i>
24" SHELF	RIM231.24	\$ 65.00
30" SHELF	RIM231.30	\$ 69.00
36" SHELF	RIM231.36	\$ 71.00
42" SHELF	RIM231.42	\$ 74.00
48" SHELF	RIM231.48	\$ 79.00
60" SHELF	RIM231.60	\$ 85.00

Refurbished: Looks like new, with new fabric

"A" SERIES OVERHEAD STORAGE

Specify:

- * Product numbe.
- * Product color – (LN, MT, DT, HF)
- * Fabric style & color for flipper door

Note:

- * Flipper Door is lockable.
- * Locks can be keyed alike upon request.

"A" SERIES FLIPPER DOOR KIT, FABRIC COVERED

DESIGNED TO BE COMPATIBLE WITH STANDARD HIGH SHELF UNIT TO MAKE A COMPLETE FLIPPER UNIT
THIS KIT DOES NOT INCLUDE THE SHELF OR HIGH SHELF ENDS.

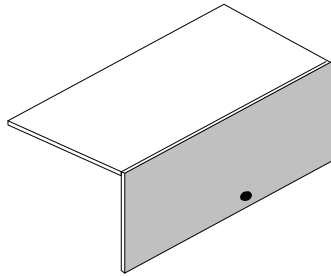

<i>DIMENSION</i> W x H x D	<i>ITEM</i> NUMBER	<i>REFURBISHED</i>	
24 x 12.5	RIM084.24	\$	71.00
30 x 12.5	RIM084.30	\$	75.00
36 x 12.5	RIM084.36	\$	79.00
42 x 12.5	RIM084.42	\$	86.00
48 x 12.5	RIM084.48	\$	88.00
60 x 12.5	RIM084.60	\$	96.00

"A" SERIES EDP FLIPPER DOOR KIT, FABRIC COVERED

DESIGNED TO BE COMPATIBLE WITH THE EDP HIGH SHELF UNIT TO MAKE A COMPLETE FLIPPER UNIT FOR LEGAL SIZE DOCUMENTS.
THIS KIT DOES NOT INCLUDE THE EDP SHELF OR HIGH SHELF ENDS.

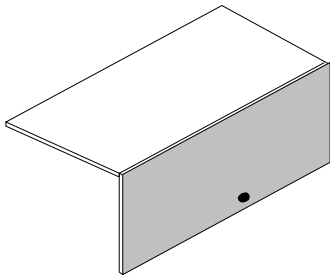

<i>DIMENSION:</i> W x H x D	<i>ITEM</i> NUMBER	<i>REFURBISHED</i>	
24 x 15.5	RIM185.24	\$	89.00
30 x 15.5	RIM185.30	\$	96.00
36 x 15.5	RIM185.36	\$	99.00
42 x 15.5	RIM185.42	\$	113.00
48 x 15.5	RIM185.48	\$	115.00
60 x 15.5	RIM185.60	\$	125.00

"A" SERIES TACKBOARDS, FABRIC COVERED
 INCLUDES TACKBOARD CLIPS & HARDWARE FOR MOUNTING

Specify:

- * Product number
- * Fabric style & color

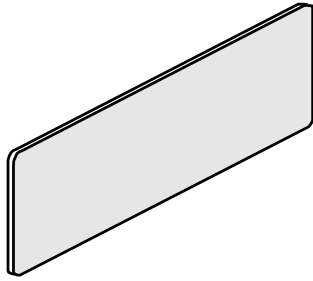

<i>DIMENSION:</i> H x W	<i>ITEM</i> NUMBER	<i>REFURBISHED</i>	
12 x 24	FIMTB1224	\$	38.50
12 x 30	FIMTB1230	\$	40.00
12 x 36	FIMTB1236	\$	42.00
12 x 42	FIMTB1242	\$	44.00
12 x 48	FIMTB1248	\$	45.00
12 x 60	FIMTB1260	\$	46.00
16 x 24	FIMTB1624	\$	40.00
16 x 30	FIMTB1630	\$	41.00
16 x 36	FIMTB1636	\$	43.00
16 x 42	FIMTB1642	\$	46.00
16 x 48	FIMTB1648	\$	46.00
16 x 60	FIMTB1660	\$	48.00
48 X 48	FIMTB4848	\$	92.00

Refurbished: Looks like new, with new fabric

HANGING LATERAL FILE (SUBJECT TO AVAILABILITY)

Specify:

- * Product number.
- * Product color – (DT, MT, & LN WITH DT ENDS)
- * Laminate

"A" SERIES UNIT HAS LAMINATED FRONT WITH LOCK

LOCKABLE FILE HANGS FROM PANEL OR WALL STRIPS AND CAN ACCOMMODATE LETTER OR LEGAL SIZE FILES.

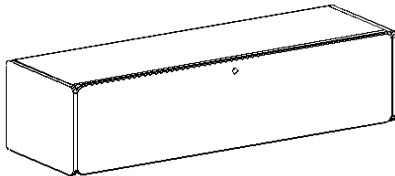

Suspended Lateral File

<i>DIMENSION:</i> W	<i>ITEM</i> NUMBER	<i>AS IS ONLY</i>	
24"	RIM130.24	\$	65.00
48"	RIM130.48	\$	75.00

FILE CONVERTER	RIMFLBAR	\$	3.50
----------------	----------	----	------

Converts file to hold front-to-back hanging files.

WHITE MARKER BOARDS

Specify:

- * Product number
- * Size

Note:

- * Laminate covered, gloss finish; choice of MT or DT trim
- * Includes lateral file clips for mounting.

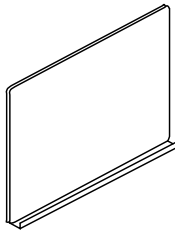

<i>DIMENSION:</i> H x W	<i>ITEM</i> NUMBER	<i>AS IS</i>	<i>NEW</i>
24x24	RIM119.24.24	*	\$ 77.00
24x36	RIM119.24.36	*	\$ 88.00
24x48	RIM119.24.48	*	\$ 109.00
36x36	RIM119.36.36	*	\$ 126.00
36x48	RIM119.36.48	*	\$ 165.00
48x48	RIM119.48.48	*	\$ 210.00

*Call for "AS IS" availability and pricing.

METAL FRONT PEDESTAL FILES

Specify:

* Product number.

* Product color - LN, MT, DT, HT (Innertone)

2 DRAWER HANGING PEDESTAL FILE

Radiused drawer fronts and recessed black pulls. For Droop Loop pulls, add \$20.00

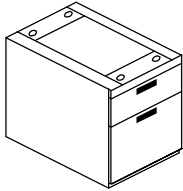

TYPE	DIMENSION:	ITEM NUMBER	NEW
BOX/FILE	21" DEEP	RIMU017.01	\$ 146.50

WORK SURFACE SUPPORTING PEDESTAL FILE

Radiused drawer fronts and recessed black pulls. For Droop Loop pulls, add \$30.00

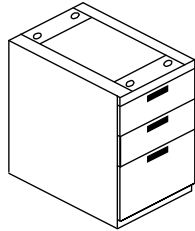

TYPE	DIMENSION:	ITEM NUMBER	NEW
FILE/FILE	21" DEEP	RIMU018.01	\$ 198.00
BOX/BOX/FILE	21" DEEP	RIMU019.01	\$ 213.00
FILE/FILE	28" DEEP	RIMU018.02	\$ 232.50
BOX/BOX/FILE	28" DEEP	RIMU019.02	\$ 260.00

MOBILE PEDESTAL FILE

Freestanding file with radiused drawer fronts and recessed black pulls. For Droop Loop pulls, add \$30.00

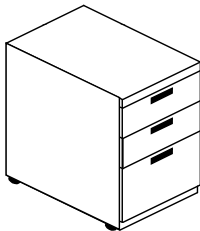

TYPE	DIMENSION:	ITEM NUMBER	NEW
FILE/FILE	22" DEEP	RIMU047.02	\$ 243.00
BOX/BOX/FILE	22" DEEP	RIMU047.01	\$ 256.50

4 DRAWER FILE CENTER

Designed to mount underneath a worksurface. Radiused drawers fronts and recessed black pulls. For Droop Loop pulls, add \$40.00.

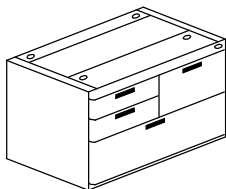

TYPE	DIMENSION: W D	ITEM NUMBER	NEW
FILE CENTER	30" X 17.5"	RIMU111.03	\$ 418.50

DRAWER DIVIDER FOR METAL PEDESTALS

Metal partition slides into pre-measured and pre-cut drawer slots. Finish: Black only

TYPE	DIMENSION:	ITEM NUMBER	NEW
BOX DIVIDER	6 INCH	RIMU060.03	\$ 2.25
FILE DIVIDER	12 INCH	RIMU060.04	\$ 3.50

METAL FRONT LATERAL FILES

Specify:

- * Product number.
- * Product color – LN, MT, DT, HT (Innertone)

TWO DRAWER LATERAL

Will accommodate letter or legal files. Black recessed pulls. For Droop Loop pulls, add \$20.00.

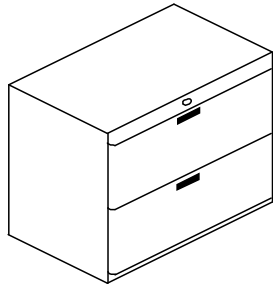

<i>DIMENSION:</i>	<i>ITEM NUMBER</i>	<i>NEW</i>	
30"	RIMU026.01	\$	345.00
36"	RIMU026.02	\$	370.00
42"	RIMU026.03	\$	405.00

THREE DRAWER LATERAL

Will accommodate letter or legal files. Black recessed pulls. For Droop Loop pulls, add \$30.00.

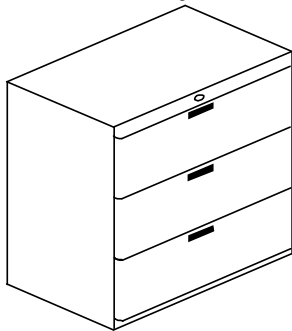

<i>DIMENSION:</i>	<i>ITEM NUMBER</i>	<i>NEW</i>	
30"	RIMU027.01	\$	435.00
36"	RIMU027.02	\$	485.00
42"	RIMU027.03	\$	540.00

FOUR DRAWER LATERAL

Will accommodate letter or legal files. Black recessed pulls. For Droop Loop pulls, add \$40.00.

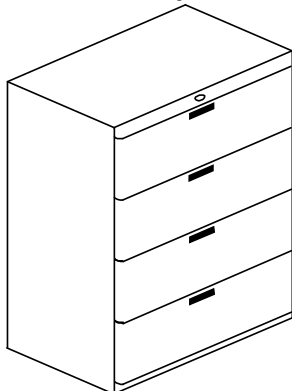

<i>DIMENSION:</i>	<i>ITEM NUMBER</i>	<i>NEW</i>	
30"	RIMU028.01	\$	545.00
36"	RIMU028.02	\$	605.00
42"	RIMU028.03	\$	665.00

FIVE DRAWER LATERAL

Will accommodate letter or legal files. Black recessed pulls. For Droop Loop pulls, add \$50.00.

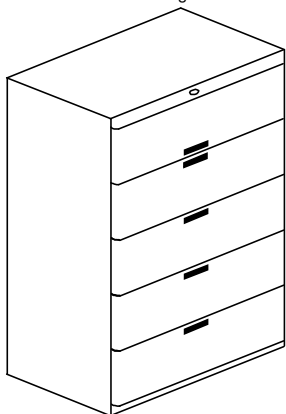

<i>DIMENSION:</i>	<i>ITEM NUMBER</i>	<i>NEW</i>	
30"	RIMU033.01	\$	685.00
36"	RIMU033.02	\$	760.00
42"	RIMU033.03	\$	850.00

ACCESSORIES

PENCIL DRAWER UNIT

DRAWER HAS FOUR COMPARTMENTS CONSTRUCTED FROM STURDY FORMED PLASTIC, WITH EASY MOUNTING BALL BEARING DRAWER SLIDES. HARDWARE FOR MOUNTING INCLUDED.

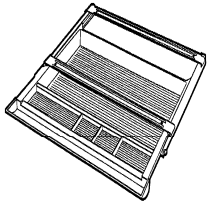

DESCRIPTION:	ITEM NUMBER	AS IS	NEW
PENCIL DRAWER	RIMU159.01.BK		\$ 18.00
Black Only			
PENCIL DRAWER	RIM285.01.DT	\$ 6.00	
SUBJECT TO AVAILABILITY			

FREESTANDING LATERAL FILE CONVERSION BAR - BLACK ONLY

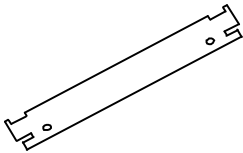

DESCRIPTION:	ITEM NUMBER	NEW
CONVERSION BAR	RIMU04801	\$ 5.00

TASK LIGHT

COMPLETE WITH MOUNTING BRACKETS - READY TO INSTALL

Specify:

- * Product number
- * Product color - (LN, MT, DT, HF)



DIMENSION:	ITEM NUMBER	NEW	NEW
			BLK ONLY DT LN MT HF
21.5"	RIMU024.24	\$ 40.00	\$ 60.00
27.5"	RIMU024.30	N/A	\$ 63.00
33.5"	RIMU024.36	\$ 46.00	\$ 65.00
45.5"	RIMU024.48	\$ 50.00	\$ 70.00
57.5"	RIMU024.60	\$ 59.00	N/A

NOTE: BLACK UNIVERSAL LIGHTS CAN NOT BE USED ON EDP SHELVES

EXTENSION BRACKET FOR EDP SHELVES			
15"	RIMU163.01	\$ 4.00	

ADJUSTABLE KEYBOARD TRAYS - BLACK ONLY

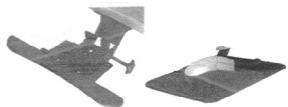

DESCRIPTION:	ITEM NUMBER	NEW
ADJ KEYBOARD WITH WRIST REST	RIMU029.03.BK	\$ 70.00
SWIVELTILT MOUSE PAD ARM	RIMU112.04.BK	\$ 48.50



^c HOUDINI ADJ KEYBOARD WITH WRIST REST AND SWIVEL/TILT MOUSE PAD ARM	RWKSLS50104-2	\$ 179.00
---	---------------	-----------